

BECKER ROAD AT WILSON GROVES

BEING A REPLAT OF A PORTION OF SECTIONS 31 AND 32, TOWNSHIP 37 SOUTH, RANGE 39 EAST, ST. LUCIE COUNTY, FLORIDA AND A PORTION OF BLOCK 6 TRACT 2, BLOCK 6 TRACT 3, BLOCK 7 AND BLOCK 8 OF THE PLAT OF THE ALAN WILSON GROVE, AS RECORDED IN PLAT BOOK 12, PAGES 50 AND 50A AND A PORTION OF THAT 150 FOOT RIGHT-OF-WAY OF NEW E/W #5 BECKER ROAD AS RECORDED IN OFFICIAL RECORDS BOOK 4704, PAGE 661 AND A PORTION OF N/S "A" ROAD AS RECORDED IN OFFICIAL RECORDS BOOK 2972, PAGE 802, TOGETHER WITH LANDS AS RECORDED IN OFFICIAL RECORDS BOOK 4965, PAGE 2432 OF THE PUBLIC RECORDS OF THE PUBLIC RECORDS OF ST. LUCIE COUNTY, FLORIDA. LYING IN SECTIONS 31 AND 32, TOWNSHIP 37 SOUTH, RANGE 39 EAST, CITY OF PORT ST. LUCIE, ST. LUCIE COUNTY, FLORIDA

THIS INSTRUMENT PREPARED BY
RONNIE L. FURNISS
OF
CAULFIELD and WHEELER, INC.
SURVEYORS - ENGINEERS - PLANNERS
7900 GLADES ROAD, SUITE 100
BOCA RATON, FLORIDA 33434 - (561)392-1991
CERTIFICATE OF AUTHORIZATION NO. LB3591

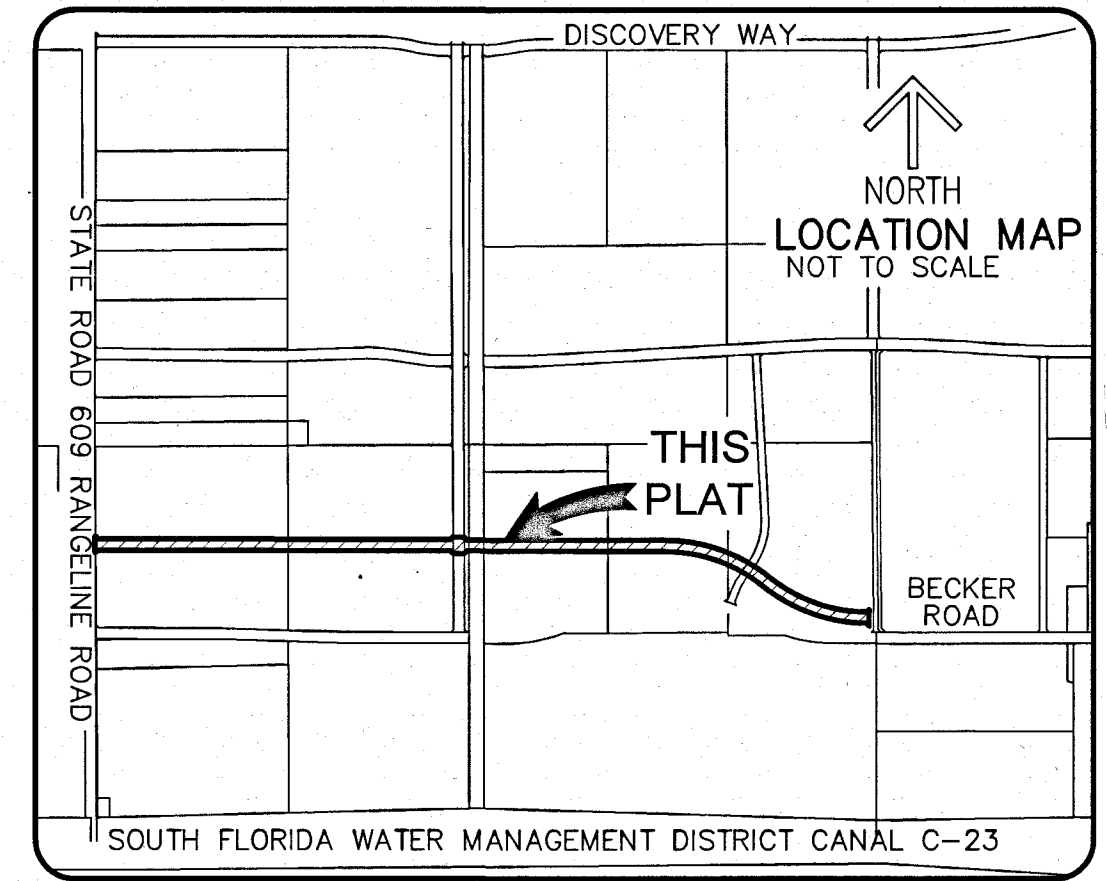

INSTR # 5289040
P BK 121 Pages 7 - 13
RECORDED 01/17/2024 08:22:20 AM
SAINT LUCIE COUNTY
DEPUTY CLERK INGRAMJ

DESCRIPTION:

A PORTION OF SECTIONS 31 AND 32, TOWNSHIP 37 SOUTH, RANGE 39 EAST, ST. LUCIE COUNTY, FLORIDA AND A PORTION OF BLOCK 4, BLOCK 6 TRACT 2, BLOCK 6 TRACT 3, BLOCK 7 AND BLOCK 8 OF THE PLAT OF THE ALAN WILSON GROVE AS RECORDED IN PLAT BOOK 12, PAGES 50 AND 50A AND A PORTION OF THAT 150 FOOT RIGHT-OF-WAY OF NEW E/W #5 BECKER ROAD AS RECORDED IN OFFICIAL RECORDS BOOK 4704, PAGE 661 AND A PORTION OF THAT 150 FOOT RIGHT-OF-WAY OF NEW E/W #5 BECKER ROAD AS RECORDED IN OFFICIAL RECORDS BOOK 4704, PAGE 661 AND A PORTION OF N/S "A" ROAD AS RECORDED IN OFFICIAL RECORDS BOOK 2972, PAGE 802 OF THE PUBLIC RECORDS OF ST. LUCIE COUNTY, FLORIDA, TOGETHER WITH LANDS AS RECORDED IN OFFICIAL RECORDS BOOK 4965, PAGE 2432 OF THE PUBLIC RECORDS OF ST. LUCIE COUNTY, FLORIDA, BEING MORE PARTICULARLY DESCRIBED AS FOLLOWS:

COMMENCING AT THE WEST QUARTER CORNER OF SAID SECTION 31; THENCE, ALONG THE WEST LINE OF SAID SECTION 31, N.00°03'37"W, A DISTANCE OF 1101.96 FEET; THENCE DEPARTING SAID WEST LINE, N.89°56'23"E, A DISTANCE OF 80.00 FEET TO A POINT OF INTERSECTION WITH THE EAST RIGHT-OF-WAY LINE OF COUNTY ROAD 609 AND THE POINT OF BEGINNING; THENCE, DEPARTING SAID EAST LINE ALONG THE NORTH RIGHT-OF-WAY LINE OF NEW E/W #5 BECKER ROAD AS RECORDED IN OFFICIAL RECORDS BOOK 4704, PAGE 661 OF SAID PUBLIC RECORDS S.44°57'57"E., A DISTANCE OF 49.42 FEET; THENCE S.89°52'17"E., A DISTANCE OF 4759.39 FEET; THENCE N.44°57'25"E., A DISTANCE OF 49.65 FEET TO A POINT OF INTERSECTION WITH THE WEST LINE OF N/S "A" ROAD AS RECORDED IN OFFICIAL RECORDS BOOK 2972, PAGE 802 OF SAID PUBLIC RECORDS; THENCE S.89°42'41"E., A DISTANCE OF 150.01 FEET TO A POINT OF INTERSECTION WITH THE EAST LINE OF SAID N/S "A" ROAD; THENCE, S.45°02'35"E., A DISTANCE OF 49.35 FEET; THENCE, S.89°52'17"E., A DISTANCE OF 2676.91 FEET TO THE POINT OF CURVATURE OF A CURVE CONCAVE TO THE SOUTHWEST HAVING A RADIUS OF 2206.00 FEET; THENCE SOUTHEASTERLY ALONG THE ARC OF SAID CURVE THROUGH A CENTRAL ANGLE OF 39°29'21", A DISTANCE OF 1520.41 FEET TO THE POINT OF REVERSE CURVATURE OF A CURVE CONCAVE TO THE NORTHEAST HAVING A RADIUS OF 2056.00 FEET; THENCE SOUTHEASTERLY ALONG THE ARC OF SAID CURVE THROUGH A CENTRAL ANGLE OF 39°31'35", A DISTANCE OF 1418.36 FEET; THENCE N.44°48'41"E., A DISTANCE OF 49.11 FEET TO THE WEST LINE OF A 20' ROAD EASEMENT BLOCK 8 OF THE PLAT OF THE ALAN WILSON GROVE; THENCE ALONG SAID WEST LINE, S.00°28'07"E., A DISTANCE OF 219.56 FEET TO A POINT OF INTERSECTION WITH THE SOUTH LINE OF SAID NEW E/W #5 BECKER ROAD; THENCE DEPARTING SAID WEST LINE AND ALONG SAID SOUTH LINE OF NEW E/W #5 BECKER ROAD, N.45°12'38"W., A DISTANCE OF 49.27 FEET TO THE POINT OF CURVATURE OF A CURVE CONCAVE TO THE NORTHEAST HAVING A RADIUS OF 2206.00 FEET FROM WHICH A RADIAL LINE BEARS N.00°02'52"E.; THENCE NORTHWESTERLY ALONG THE ARC OF SAID CURVE THROUGH A CENTRAL ANGLE OF 39°34'12", A DISTANCE OF 1523.52 FEET TO THE POINT OF REVERSE CURVATURE OF A CURVE CONCAVE TO THE SOUTHWEST HAVING A RADIUS OF 2056.00 FEET; THENCE NORTHWESTERLY ALONG THE ARC OF SAID CURVE THROUGH A CENTRAL ANGLE OF 39°29'21", A DISTANCE OF 1417.03 FEET TO THE POINT OF TANGENCY; THENCE N.89°52'17"W., A DISTANCE OF 2675.59 FEET; THENCE, S.44°57'25"W., A DISTANCE OF 49.65 FEET TO A POINT OF INTERSECTION WITH THE EAST LINE OF SAID N/S "A" ROAD; THENCE N.89°42'41"W., A DISTANCE OF 150.01 FEET TO A POINT OF INTERSECTION WITH THE WEST LINE OF N/A "A" ROAD AND THE SOUTH LINE OF SAID E/W #5 BECKER ROAD WEST; THENCE N.45°02'35"W., A DISTANCE OF 49.35 FEET; THENCE CONTINUING ALONG SAID SOUTH LINE N.89°52'17"W., A DISTANCE OF 4759.98 FEET; THENCE S.45°02'03"W., A DISTANCE OF 49.58 FEET TO A POINT OF INTERSECTION WITH SAID EAST RIGHT-OF-WAY LINE OF COUNTY ROAD 609; THENCE, ALONG SAID EAST LINE, N.00°03'37"W., A DISTANCE OF 220.00 FEET TO THE POINT OF BEGINNING.

CONTAINING 37.080 ACRES, MORE OR LESS.
SAID LANDS SITUATE IN THE CITY OF PORT ST. LUCIE, ST. LUCIE COUNTY, FLORIDA.

CERTIFICATE OF OWNERSHIP & DEDICATION:

STATE OF FLORIDA
COUNTY OF ST. LUCIE
THE CITY OF PORT ST. LUCIE, A MUNICIPAL CORPORATION, OF THE STATE OF FLORIDA, OWNER OF THE LAND DESCRIBED AND PLATTED HEREON AS BECKER ROAD AT WILSON GROVES, BEING IN ST. LUCIE COUNTY, FLORIDA, HAVE CAUSED SAID LANDS TO BE SURVEYED AND PLATTED AS SHOWN HEREON AND HEREBY DEDICATES AS FOLLOWS:

1. TRACT RW AS SHOWN OR DESCRIBED ON THIS PLAT ARE DEDICATED TO THE CITY OF PORT ST. LUCIE, A MUNICIPAL CORPORATION, OF THE STATE OF FLORIDA, FOR THE BENEFIT OF THE PUBLIC, FOR ROAD RIGHT-OF-WAY PURPOSES.

IN WITNESS WHEREOF, THE ABOVE NAMED MUNICIPAL CORPORATION, OF THE STATE OF FLORIDA, HAS CAUSED THESE PRESENTS TO BE SIGNED BY ITS MAYOR THIS _____ DAY OF _____ 2024.

CITY OF PORT ST. LUCIE, A MUNICIPAL CORPORATION, OF THE STATE OF FLORIDA.

BY: Shannon M. Martin
SHANNON M. MARTIN, MAYOR

[Signature]
SIGNATURE
Shanna Donleam
PRINTED NAME
[Signature]
SIGNATURE
Daisy Ruiz
PRINTED NAME

ACKNOWLEDGMENT:

STATE OF FLORIDA
COUNTY OF ST. LUCIE
THE FOREGOING INSTRUMENT WAS ACKNOWLEDGED BEFORE ME BY MEANS OF PHYSICAL PRESENCE OR ONLINE NOTARIZATION, THIS 16th DAY OF January, 2024, BY SHANNON M. MARTIN, MAYOR, ON BEHALF OF THE CITY OF PORT ST. LUCIE, A MUNICIPAL CORPORATION OF THE STATE OF FLORIDA, WHO IS PERSONALLY KNOWN TO ME OR HAS PRODUCED _____ AS IDENTIFICATION.

WITNESS MY HAND AND OFFICIAL SEAL IN THE COUNTY AND STATE LAST AFORESAID THIS 16th DAY OF January, 2024.
[Signature]
COMMISSION NO. & EXPIRATION DATE
NOTARY PUBLIC, STATE OF FLORIDA

COMMISSION NO. & EXPIRATION DATE
11301493 Nov 8, 2028

NOTARY PUBLIC, STATE OF FLORIDA

PRINT NAME: Sally Walsh

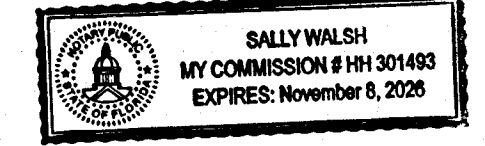

TITLE CERTIFICATION:

STATE OF FLORIDA
COUNTY OF PALM BEACH

- THE UNDERSIGNED, JEFFREY J. WOLFE, A DULY LICENSED ATTORNEY IN THE STATE OF FLORIDA, DOES HEREBY CERTIFY THAT, AS OF THE 4 DAY OF January, 2024:
- THE RECORD TITLE TO THE LAND AS DESCRIBED AND SHOWN HEREON IS IN THE NAME OF THE CITY OF PORT ST. LUCIE, A MUNICIPAL CORPORATION OF THE STATE OF FLORIDA, THE ENTITY EXECUTING THE DEDICATION.
- THERE IS NO MORTGAGE OF RECORD, ENCUMBERING THE LAND DESCRIBED HEREIN.
- PURSUANT TO FLORIDA STATUTES 197.192, ALL TAXES HAVE BEEN PAID THROUGH THE YEAR 2023.
- ALL ASSESSMENTS CURRENTLY DUE AND PAYABLE AGAINST SAID LAND HAVE BEEN SATISFIED.
- THERE ARE ENCUMBRANCES OF RECORD BUT THOSE ENCUMBRANCES DO NOT PROHIBIT THE CREATION OF THE SUBDIVISION DEPICTED BY THIS PLAT.

DATED THIS 4 DAY OF January, 2024

[Signature]
JEFFREY J. WOLFE
FLORIDA BAR NO. 135630
SACHS SAX CAPLAN, P.L.
6111 BROKEN SOUND PKWY NW, SUITE 200
BOCA RATON, FL 33487

SURVEYOR'S NOTES:

- 1) BEARINGS AS SHOWN HEREON ARE GRID DATUM, NAD 83 1990 ADJUSTMENT, FLORIDA EAST ZONE, BASED ON THE WEST LINE OF SECTION 31, TOWNSHIP 37 SOUTH, RANGE 39 EAST, ST. LUCIE COUNTY, FLORIDA, GRID BEARING N.00°03'37"W.
- 2) ALL LINES INTERSECTING CIRCULAR CURVES ARE NON-RADIAL UNLESS OTHERWISE NOTED.
- 3) NOTE: THIS PLAT HAS BEEN REVIEWED FOR CONFORMITY TO CHAPTER 177, PART 1, PLATTING, FLORIDA STATUTES, BY A PROFESSIONAL SURVEYOR AND MAPPER EMPLOYED BY OR UNDER CONTRACT WITH THE CITY OF PORT ST. LUCIE.
- 4) "NOTICE" THIS PLAT, AS RECORDED IN ITS GRAPHIC FORM, IS THE OFFICIAL DEPICTION OF THE SUBDIVIDED LANDS DESCRIBED HEREIN AND WILL IN NO CIRCUMSTANCES BE SUPPLANTED IN AUTHORITY BY ANY OTHER GRAPHIC OR DIGITAL FORM OF THE PLAT. THERE MAY BE ADDITIONAL RESTRICTIONS THAT ARE NOT RECORDED ON THIS PLAT THAT MAY BE FOUND IN THE PUBLIC RECORDS OF ST. LUCIE COUNTY.

SURVEYOR'S CERTIFICATE:

STATE OF FLORIDA
COUNTY OF ST. LUCIE

THIS IS TO CERTIFY THAT THE PLAT AS SHOWN HEREON IS A TRUE AND CORRECT REPRESENTATION OF A SURVEY MADE UNDER MY RESPONSIBLE DIRECTION AND SUPERVISION AND THAT SAID SURVEY IS ACCURATE TO THE BEST OF MY KNOWLEDGE AND BELIEF AND THAT PERMANENT REFERENCE MONUMENTS (P.R.M.'S) HAVE BEEN SET AND THAT PERMANENT CONTROL POINTS (P.C.P.'S) WILL BE SET UNDER THE GUARANTEES POSTED WITH THE CITY COUNCIL OF PORT ST. LUCIE FOR THE REQUIRED IMPROVEMENTS, AND FURTHER, THAT THE SURVEY DATA COMPLIES WITH ALL OF THE REQUIREMENTS OF CHAPTER 177, FLORIDA STATUTES, AS AMENDED, AND IN ACCORDANCE WITH THE SURVEYING STANDARDS CONTAINED WITHIN CHAPTER 51-17, FLORIDA ADMINISTRATIVE CODE, SET FORTH BY THE FLORIDA BOARD OF SURVEYORS AND MAPPERS PURSUANT TO SECTION 472.027, FLORIDA STATUTES, AND ORDINANCES OF THE CITY OF PORT ST. LUCIE, FLORIDA. THIS 16 DAY OF January, 2024.

[Signature]
RONNIE L. FURNISS
PROFESSIONAL SURVEYOR MAPPER #6272
STATE OF FLORIDA
CAULFIELD AND WHEELER, INC
SURVEYORS - ENGINEERS - PLANNERS
7900 GLADES ROAD, SUITE 100
(561)392-1991
CERTIFICATION OF AUTHORIZATION NO. LB 3591

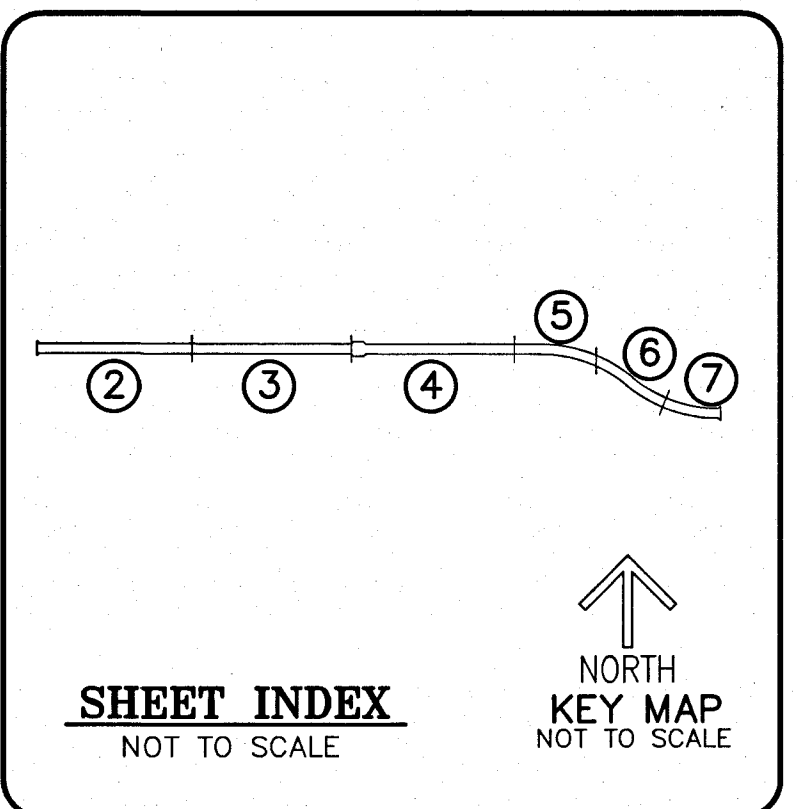

CLERK'S RECORDING CERTIFICATE:

STATE OF FLORIDA
COUNTY OF ST. LUCIE

I, MICHELLE M. MILLER, CLERK OF THE CIRCUIT COURT OF ST. LUCIE COUNTY, FLORIDA, DO HEREBY CERTIFY THAT THIS PLAT HAS BEEN EXAMINED, AND THAT IT COMPLIES IN FORM WITH ALL THE REQUIREMENTS OF THE LAWS OF FLORIDA PERTAINING TO MAPS AND PLATS, AND THAT THIS PLAT HAS BEEN FILED FOR RECORD IN PLAT BOOK 121, PAGE(S) 7-13 OF THE PUBLIC RECORDS OF ST. LUCIE COUNTY, FLORIDA, THIS 17 DAY OF January, 2024.

[Signature] Deputy Clerk
MICHELLE M. MILLER
CLERK OF THE CIRCUIT COURT
ST. LUCIE COUNTY, FLORIDA

APPROVAL OF CITY:

STATE OF FLORIDA
CITY OF PORT ST. LUCIE

IT IS HEREBY CERTIFIED THAT THIS PLAT OF BECKER ROAD AT WILSON GROVES, HAS BEEN OFFICIALLY APPROVED, INCLUDING THE RELEASE OF ALL PRIOR DEDICATIONS APPLICABLE TO THE LANDS BEING PLATTED HEREIN AND ALL DEDICATIONS TO THE CITY OF PORT ST. LUCIE HEREIN ARE ACCEPTED FOR RECORD BY THE CITY COUNCIL OF THE CITY OF PORT ST. LUCIE, FLORIDA, THIS 8th DAY OF January, 2024.

ATTEST:
[Signature]
SALLY WALSH, CITY CLERK

CITY OF PORT ST. LUCIE
[Signature]
SHANNON M. MARTIN, MAYOR

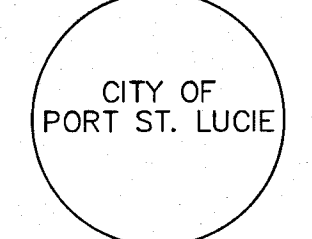

BECKER ROAD AT WILSON GROVES

BEING A REPLAT OF A PORTION OF SECTIONS 31 AND 32, TOWNSHIP 37 SOUTH, RANGE 39 EAST, ST. LUCIE COUNTY, FLORIDA AND A PORTION OF BLOCK 6 TRACT 2, BLOCK 6 TRACT 3, BLOCK 7 AND BLOCK 8 OF THE PLAT OF THE ALAN WILSON GROVE, AS RECORDED IN PLAT BOOK 12, PAGES 50 AND 50A AND A PORTION OF THAT 150 FOOT RIGHT-OF-WAY OF NEW E/W #5 BECKER ROAD AS RECORDED IN OFFICIAL RECORDS BOOK 4704, PAGE 661 AND A PORTION OF N/S "A" ROAD AS RECORDED IN OFFICIAL RECORDS BOOK 2972, PAGE 802, TOGETHER WITH LANDS AS RECORDED IN OFFICIAL RECORDS BOOK 4965, PAGE 2432 OF THE PUBLIC RECORDS OF THE PUBLIC RECORDS OF ST. LUCIE COUNTY, FLORIDA. LYING IN SECTIONS 31 AND 32, TOWNSHIP 37 SOUTH, RANGE 39 EAST, CITY OF PORT ST. LUCIE, ST. LUCIE COUNTY, FLORIDA

THIS INSTRUMENT PREPARED BY
RONNIE L. FURNISS
OF
CAULFIELD and WHEELER, INC.
SURVEYORS - ENGINEERS - PLANNERS
7900 GLADES ROAD, SUITE 100
BOCA RATON, FLORIDA 33434 - (561)392-1991
CERTIFICATE OF AUTHORIZATION NO. LB3591

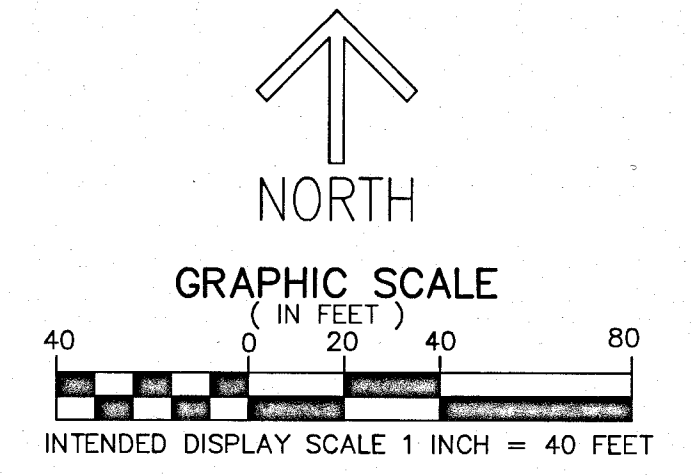
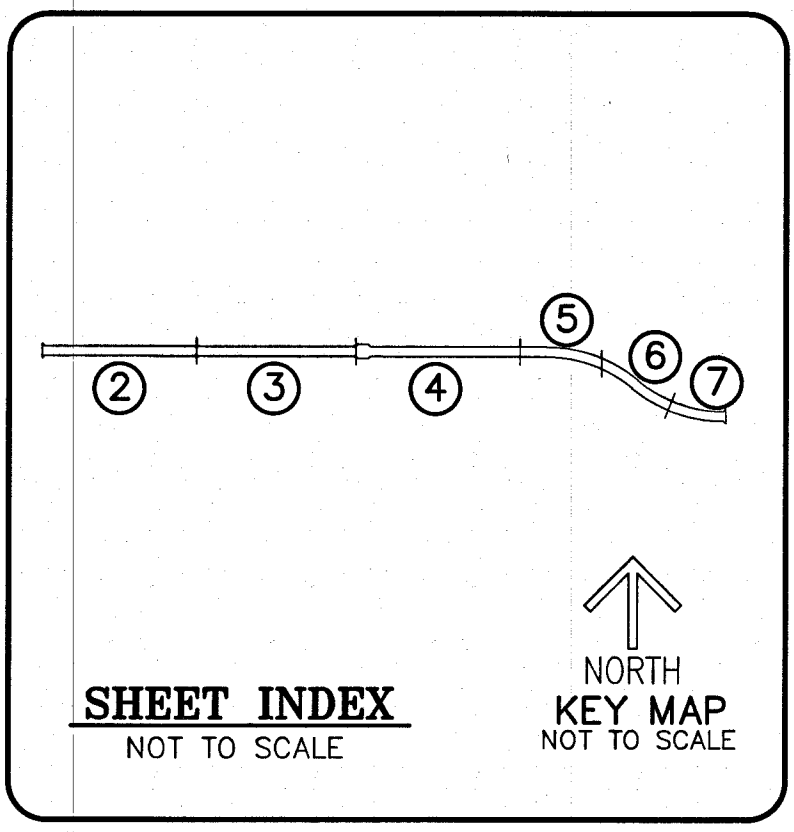

- LEGEND/ABBREVIATIONS**
- CL - CENTERLINE
 - Δ - DELTA (CENTRAL ANGLE)
 - AC - ACRES
 - CB - CHORD BEARING
 - CD - CHORD DISTANCE
 - E/W - EAST-WEST
 - L - ARC LENGTH
 - LB - LICENSED BUSINESS
 - ORB - OFFICIAL RECORD BOOK
 - PUE - PRIVATE UTILITY EASEMENT
 - POB - POINT OF BEGINNING
 - POC - POINT OF COMMENCEMENT
 - R - RADIUS
 - (RB) - RADIAL BEARING
 - SF - SQUARE FEET
 - PRM - PERMANENT REFERENCE MONUMENT SET 5/8" IRON ROD WITH CAP STAMPED "C&W PRM LB3591"
 - ⊙ PCP - DENOTES PERMANENT CONTROL POINT SET 5/8" IRON ROD WITH CAP STAMPED "C&W PCP LB3591"
 - - DENOTES 4"x 4" CONCRETE MONUMENT STAMPED "C&W PRM LB3591"
 - X - 1/4 CORNER SECTION

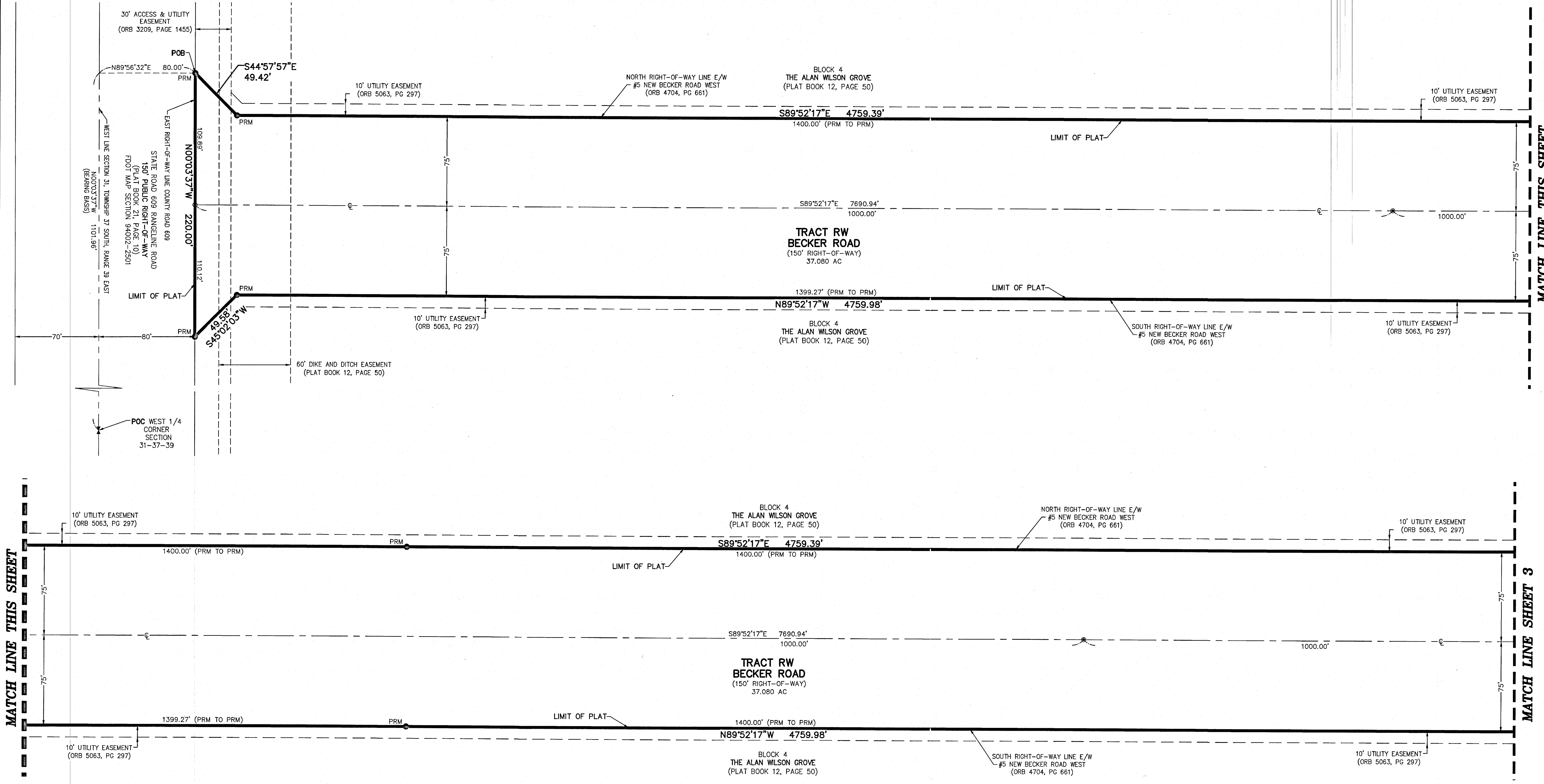

BECKER ROAD AT WILSON GROVES

BEING A REPLAT OF A PORTION OF SECTIONS 31 AND 32, TOWNSHIP 37 SOUTH, RANGE 39 EAST, ST. LUCIE COUNTY, FLORIDA AND A PORTION OF BLOCK 6 TRACT 2, BLOCK 6 TRACT 3, BLOCK 7 AND BLOCK 8 OF THE PLAT OF THE ALAN WILSON GROVE, AS RECORDED IN PLAT BOOK 12, PAGES 50 AND 50A AND A PORTION OF THAT 150 FOOT RIGHT-OF-WAY OF NEW E/W #5 BECKER ROAD AS RECORDED IN OFFICIAL RECORDS BOOK 4704, PAGE 661 AND A PORTION OF N/S "A" ROAD AS RECORDED IN OFFICIAL RECORDS BOOK 2972, PAGE 802, TOGETHER WITH LANDS AS RECORDED IN OFFICIAL RECORDS BOOK 4965, PAGE 2432 OF THE PUBLIC RECORDS OF THE PUBLIC RECORDS OF ST. LUCIE COUNTY, FLORIDA. LYING IN SECTIONS 31 AND 32, TOWNSHIP 37 SOUTH, RANGE 39 EAST, CITY OF PORT ST. LUCIE, ST. LUCIE COUNTY, FLORIDA

THIS INSTRUMENT PREPARED BY
RONNIE L. FURNISS
OF
CAULFIELD and WHEELER, INC.
SURVEYORS - ENGINEERS - PLANNERS
7900 GLADES ROAD, SUITE 100
BOCA RATON, FLORIDA 33434 - (561)392-1991
CERTIFICATE OF AUTHORIZATION NO. LB3591

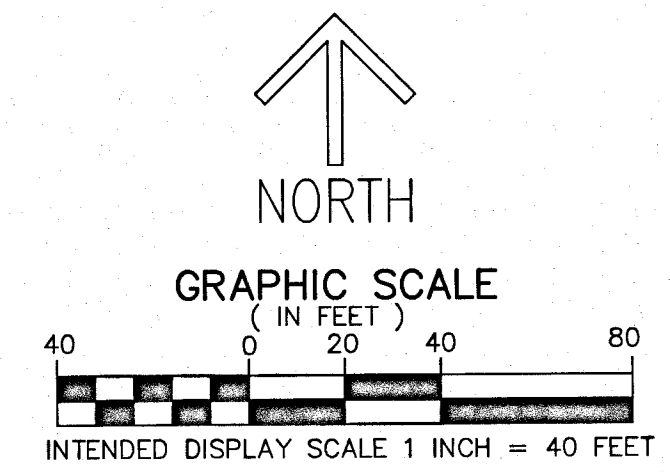
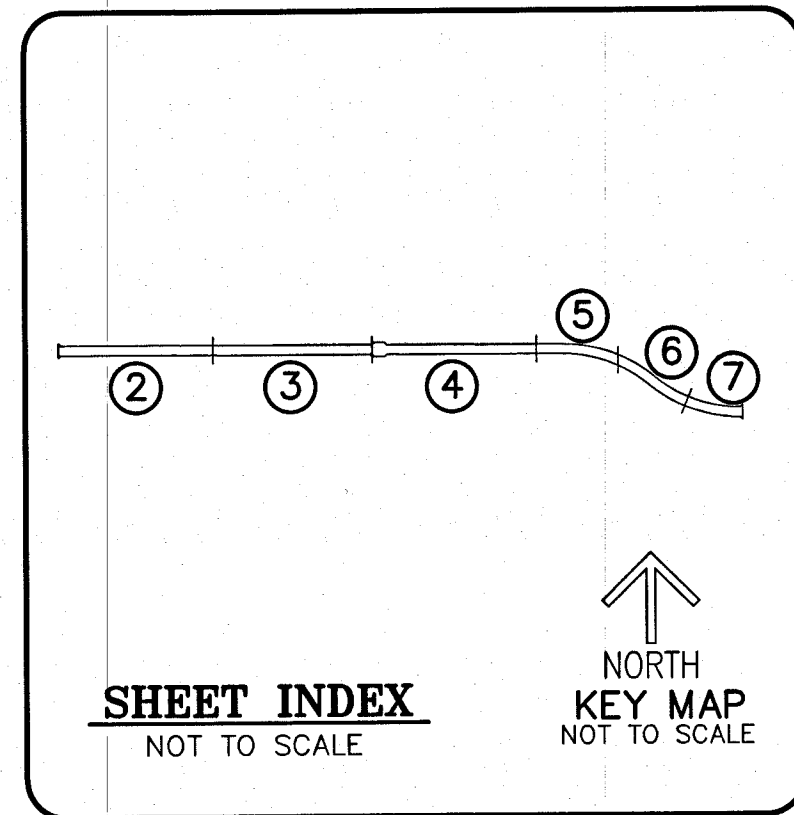

LEGEND/ABBREVIATIONS

- CL - CENTERLINE
- Δ - DELTA (CENTRAL ANGLE)
- AC - ACRES
- CB - CHORD BEARING
- CD - CHORD DISTANCE
- E/W - EAST-WEST
- L - ARC LENGTH
- LB - LICENSED BUSINESS
- ORB - OFFICIAL RECORD BOOK
- PUE - PRIVATE UTILITY EASEMENT
- POB - POINT OF BEGINNING
- POC - POINT OF COMMENCEMENT
- R - RADIUS
- (RB) - RADIAL BEARING
- SF - SQUARE FEET
- PRM - PERMANENT REFERENCE MONUMENT SET 5/8" IRON ROD WITH CAP STAMPED "C&W PRM LB3591"
- ⊙ PCP - DENOTES PERMANENT CONTROL POINT SET 5/8" IRON ROD WITH CAP STAMPED "C&W PCP LB3591"
- - DENOTES 4" x 4" CONCRETE MONUMENT STAMPED "C&W PRM LB3591"
- ⊥ - 1/4 CORNER SECTION

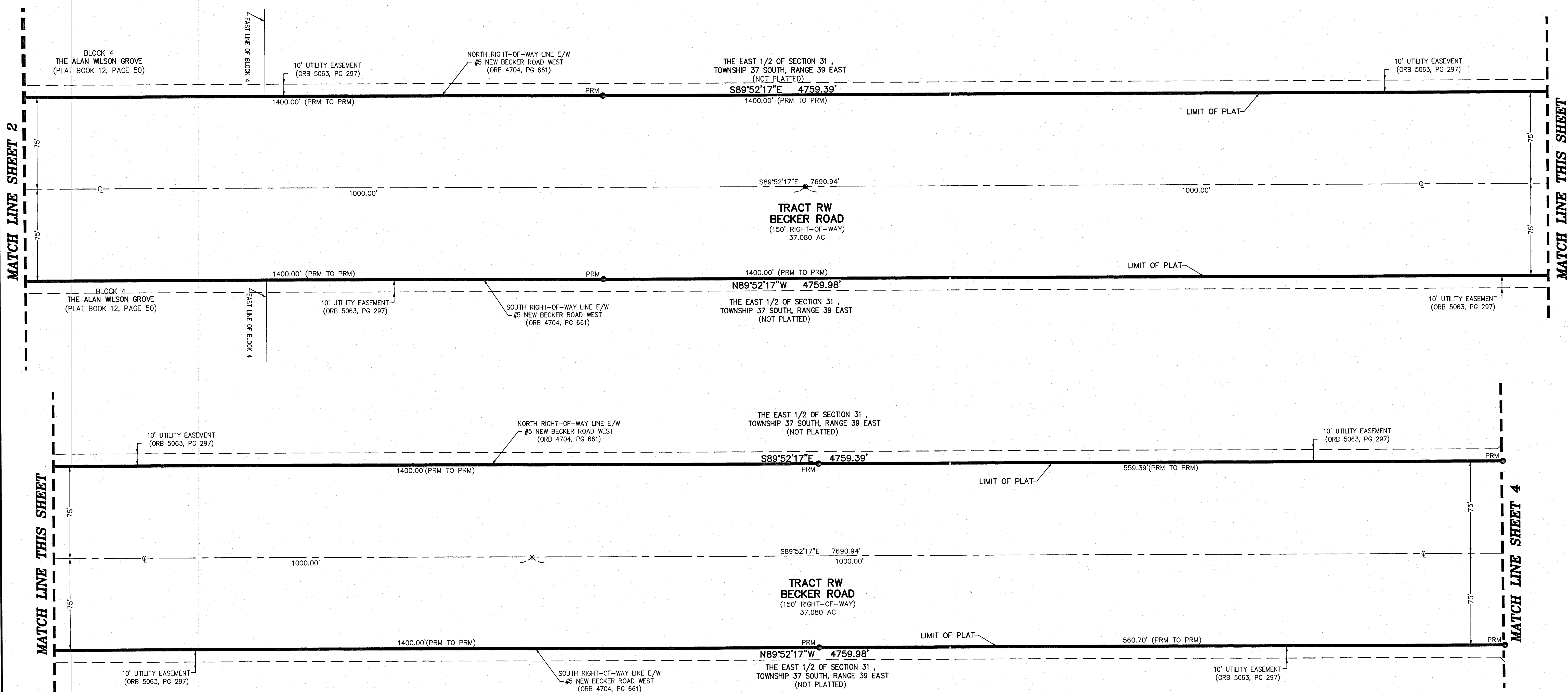

BECKER ROAD AT WILSON GROVES

BEING A REPLAT OF A PORTION OF SECTIONS 31 AND 32, TOWNSHIP 37 SOUTH, RANGE 39 EAST, ST. LUCIE COUNTY, FLORIDA AND A PORTION OF BLOCK 6 TRACT 2, BLOCK 6 TRACT 3, BLOCK 7 AND BLOCK 8 OF THE PLAT OF THE ALAN WILSON GROVE, AS RECORDED IN PLAT BOOK 12, PAGES 50 AND 50A AND A PORTION OF THAT 150 FOOT RIGHT-OF-WAY OF NEW E/W #5 BECKER ROAD AS RECORDED IN OFFICIAL RECORDS BOOK 4704, PAGE 661 AND A PORTION OF N/S "A" ROAD AS RECORDED IN OFFICIAL RECORDS BOOK 2972, PAGE 802, TOGETHER WITH LANDS AS RECORDED IN OFFICIAL RECORDS BOOK 4965, PAGE 2432 OF THE PUBLIC RECORDS OF THE PUBLIC RECORDS OF ST. LUCIE COUNTY, FLORIDA. LYING IN SECTIONS 31 AND 32, TOWNSHIP 37 SOUTH, RANGE 39 EAST, CITY OF PORT ST. LUCIE, ST. LUCIE COUNTY, FLORIDA

THIS INSTRUMENT PREPARED BY
 RONNIE L. FURNISS
 OF
CAULFIELD and WHEELER, INC.
 SURVEYORS - ENGINEERS - PLANNERS
 7900 GLADES ROAD, SUITE 100
 BOCA RATON, FLORIDA 33434 - (561)392-1991
 CERTIFICATE OF AUTHORIZATION NO. LB3591

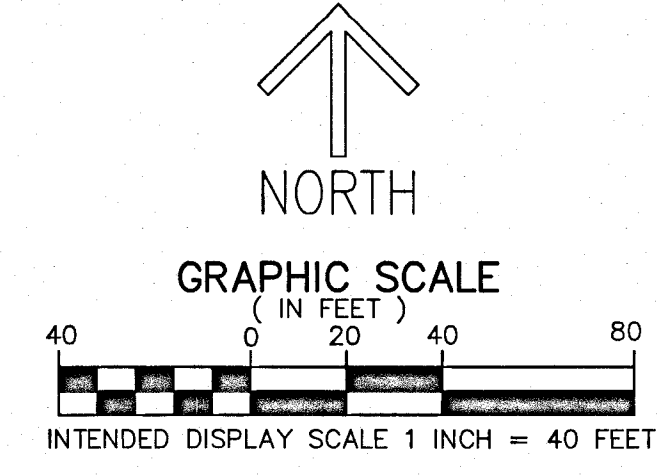
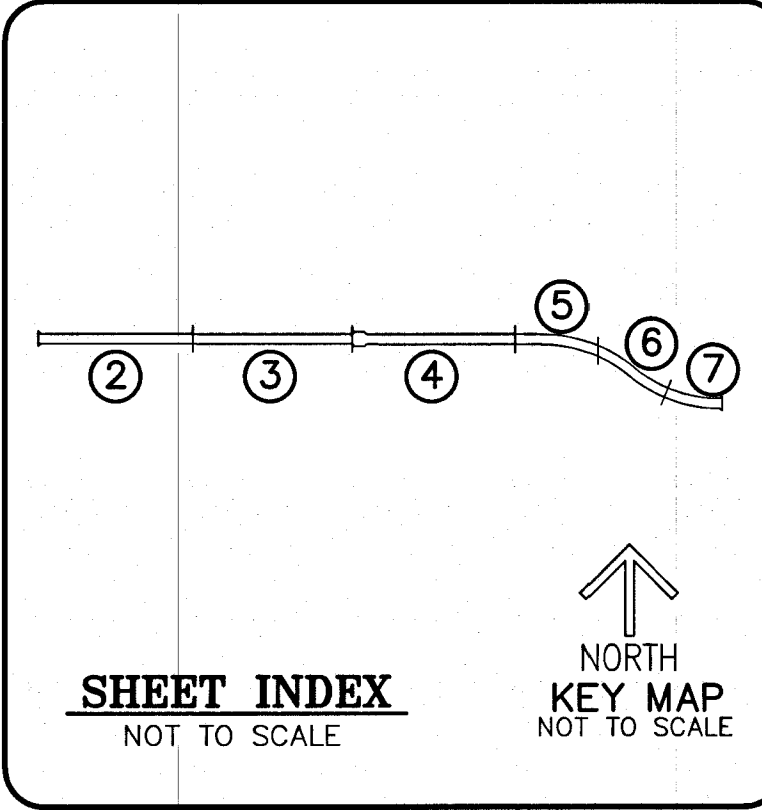

- LEGEND/ABBREVIATIONS**
- Δ - CENTERLINE
 - Δ - DELTA (CENTRAL ANGLE)
 - AC - ACRES
 - CB - CHORD BEARING
 - CD - CHORD DISTANCE
 - E/W - EAST-WEST
 - L - ARC LENGTH
 - LB - LICENSED BUSINESS
 - ORB - OFFICIAL RECORD BOOK
 - PUE - PRIVATE UTILITY EASEMENT
 - POB - POINT OF BEGINNING
 - POC - POINT OF COMMENCEMENT
 - R - RADIUS
 - (RB) - RADIAL BEARING
 - SF - SQUARE FEET
 - PRM - PERMANENT REFERENCE MONUMENT SET 5/8" IRON ROD WITH CAP STAMPED "C&W PRM LB3591"
 - ⊙ PCP - DENOTES PERMANENT CONTROL POINT SET 5/8" IRON ROD WITH CAP STAMPED "C&W PCP LB3591"
 - - DENOTES 4" x 4" CONCRETE MONUMENT STAMPED "C&W PRM LB3591"
 - ┌ - 1/4 CORNER SECTION

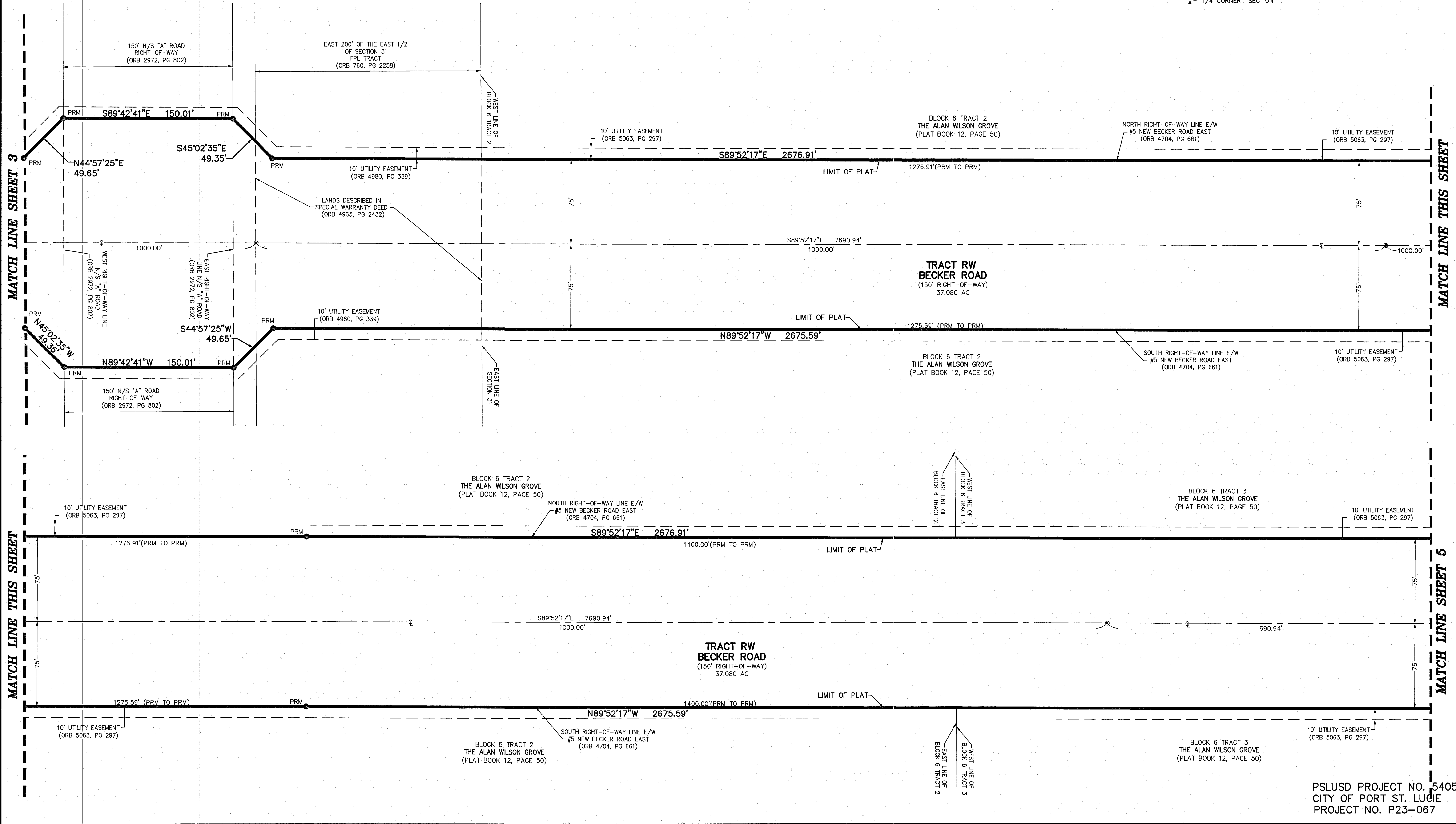

BECKER ROAD AT WILSON GROVES

BEING A REPLAT OF A PORTION OF SECTIONS 31 AND 32, TOWNSHIP 37 SOUTH, RANGE 39 EAST, ST. LUCIE COUNTY, FLORIDA AND A PORTION OF BLOCK 6 TRACT 2, BLOCK 6 TRACT 3, BLOCK 7 AND BLOCK 8 OF THE PLAT OF THE ALAN WILSON GROVE, AS RECORDED IN PLAT BOOK 12, PAGES 50 AND 50A AND A PORTION OF THAT 150 FOOT RIGHT-OF-WAY OF NEW E/W #5 BECKER ROAD AS RECORDED IN OFFICIAL RECORDS BOOK 4704, PAGE 661 AND A PORTION OF N/S "A" ROAD AS RECORDED IN OFFICIAL RECORDS BOOK 2972, PAGE 802, TOGETHER WITH LANDS AS RECORDED IN OFFICIAL RECORDS BOOK 4965, PAGE 2432 OF THE PUBLIC RECORDS OF THE PUBLIC RECORDS OF ST. LUCIE COUNTY, FLORIDA. LYING IN SECTIONS 31 AND 32, TOWNSHIP 37 SOUTH, RANGE 39 EAST, CITY OF PORT ST. LUCIE, ST. LUCIE COUNTY, FLORIDA

THIS INSTRUMENT PREPARED BY
RONNIE L. FURNISS
OF
CAULFIELD and WHEELER, INC.
SURVEYORS - ENGINEERS - PLANNERS
7900 GLADES ROAD, SUITE 100
BOCA RATON, FLORIDA 33434 - (561)392-1991
CERTIFICATE OF AUTHORIZATION NO. LB3591

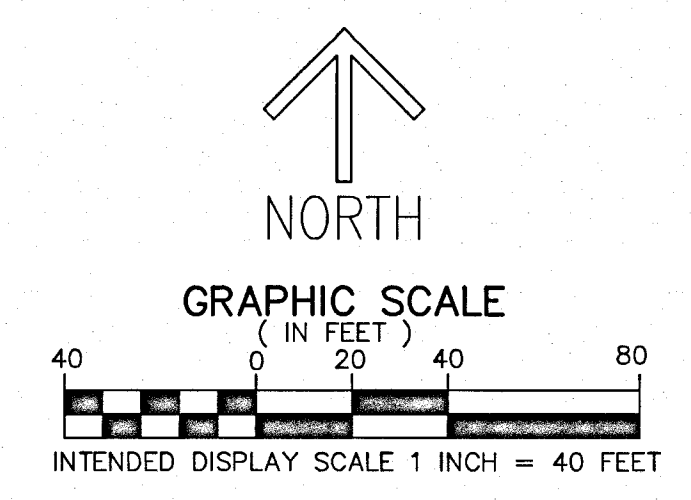
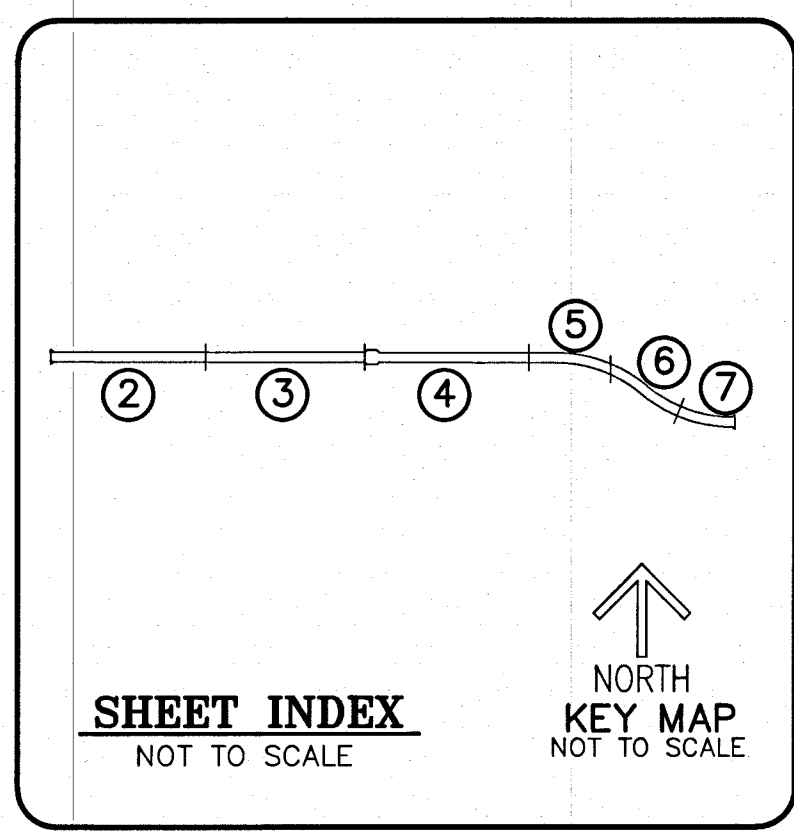

- LEGEND/ABBREVIATIONS**
- CL - CENTERLINE
 - Δ - DELTA (CENTRAL ANGLE)
 - AC - ACRES
 - CB - CHORD BEARING
 - CD - CHORD DISTANCE
 - E/W - EAST-WEST
 - L - ARC LENGTH
 - LB - LICENSED BUSINESS
 - ORB - OFFICIAL RECORD BOOK
 - PUE - PRIVATE UTILITY EASEMENT
 - POB - POINT OF BEGINNING
 - POC - POINT OF COMMENCEMENT
 - R - RADIUS
 - (RB) - RADIAL BEARING
 - SF - SQUARE FEET
 - PRM - PERMANENT REFERENCE MONUMENT SET 5/8" IRON ROD WITH CAP STAMPED "C&W PRM LB3591"
 - ⊙ PCP - DENOTES PERMANENT CONTROL POINT SET 5/8" IRON ROD WITH CAP STAMPED "C&W PCP LB3591"
 - - DENOTES 4"x 4" CONCRETE MONUMENT STAMPED "C&W PRM LB3591"
 - ┌ - 1/4 CORNER SECTION

